

TANITA®

Monitoring Your Health

Instruction Manual

WBGT Heat Index Meter

TT-563

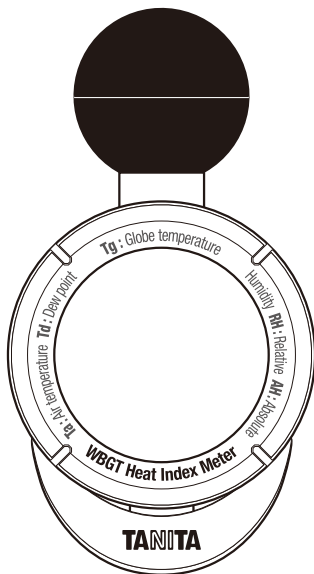

What is Wet-Bulb Globe Temperature?

Wet-Bulb Globe Temperature (WBGT) is a summer heat index that indicates the level of severity of heat. In addition to the air temperature, the calculations of this heat index take into account humidity (which affects sweating) and forms of radiant heat such as solar radiation and reflected heat. The index is calculated from dry-bulb temperature (ambient temperature), wet-bulb temperature (related to humidity) and black globe temperature (related to radiant heat). The result is expressed as a temperature in Celsius (°C).

Outside (with solar radiation):

$0.7 \times \text{wet-bulb temperature} + 0.2 \times \text{black globe temperature} + 0.1 \times \text{dry-bulb temperature}$

Inside (no solar radiation):

$0.7 \times \text{wet-bulb temperature} + 0.3 \times \text{black globe temperature}$

This device measures the dry-bulb temperature with a thermistor and calculates the wet-bulb temperature from the dry-bulb temperature and a relative humidity value measured with a humidity sensor. The black globe temperature is calculated by converting the temperature measured with a 33mm-wide black globe to the equivalent value for a standard 150mm-wide black globe. This device also uses the difference between the dry-bulb temperature (ambient temperature) and black globe temperature to predict whether the user is outside (where there is solar radiation) or inside (where there is no solar radiation). The WBGT is then displayed according to this automatic judgment.

Safety Notes

This section explains precautionary measures to be taken to avoid injury to the users of this device and others, and to prevent damage to property. Please familiarize yourself with this information to ensure safe operation of this equipment.

 **Warning** Failure to follow instructions highlighted with this mark could result in death or severe injury.

 **Caution** Failure to follow instructions highlighted with this mark could result in injury or damage to property.



This mark indicates actions that are prohibited.



This mark indicates instructions that must always be followed.

Safety Notes

Warning

Be sure to understand the specifications of this product before use, and use it as a guide for heatstroke countermeasures. Please note that TANITA cannot accept any responsibility whatsoever for secondary accidents that may occur due to errors in accuracy of the device.



MUST BE OBSERVED

Stop using this device immediately if a malfunction occurs. Additionally, mark the device as “out of order” and store it in a location where another person will not use it by accident. In the worst-case scenario, playing sports or other physical activities based on WBGT measurements taken using a malfunctioning device may result in death or serious injury.

Caution





Prohibited

- Keep the battery away from children.
- This device is manufactured using a precise electrical circuit. Therefore, do not handle roughly or expose to powerful shocks.
- Never attempt to disassemble this device. Doing so will result in malfunction.
- This device is not dust proof or splash proof. Do not use in locations where there is a lot of dust, high humidity, or where the device may be splashed with water.
- Do not use or store in an environment where there are organic solvents or corrosive gases.
- Do not use in hot temperature (ambient temperature exceeding 50°C) locations (such as inside a parked vehicle during summer), or near a heating appliance.



MUST BE OBSERVED

- When using a tripod, etc., be sure to fix the device securely and ensure the tripod can withstand the weight of this device.
- Use a soft cloth to wipe off any dirt from the device.
- Do not use alcohol, boiling water, thinner or benzine.
- The usable temperature range of this device is 0°C to 50°C. Using in a location where the temperature is outside may result in malfunction or the display becoming unreadable.
- “” appears in the display when the batteries are worn. Accuracy cannot be guaranteed if the device is used when “” is displayed.

Names of Parts

<Front>

Black Globe
Temperature Sensor

Display

Protective Cover for
Temperature Sensor

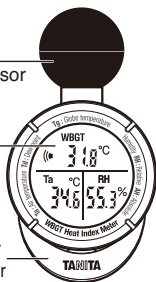

<Side>

MODE Button

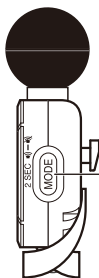

<Back>

ON/OFF
Button

Hook

Battery Cover

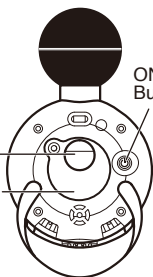

Carabiner
(Accessory)

Hanging Attachment
(Accessory)

Battery Cover for
Attaching to a Tripod
(Accessory)

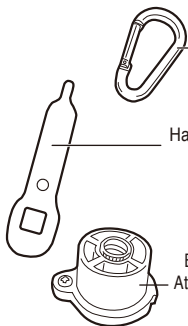

Accessories

- Instruction Manual (This Manual)
- Hanging attachments (1 white, 1 blue)
- Carabiner (1)
- Battery cover for attaching to a tripod (1)
- Screwdriver (1)
- Test Battery (CR2032× 1)

•The test battery is provided from the factory and has a shorter lifespan than ordinary batteries.

Inserting the Battery

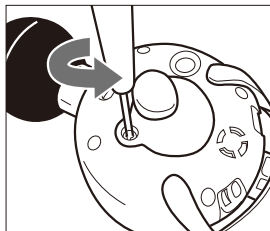

1. Use the provided screwdriver or a small commercially available small screwdriver to unscrew the screws in the counter-clockwise direction and remove them.

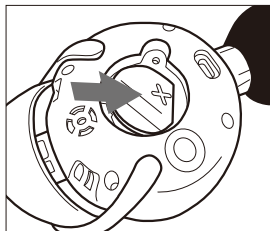

2. Insert the battery (CR2032) with the “+” side facing upwards in the direction of the arrow. When the battery is inserted, a “beep” sound is heard and the power turns on.

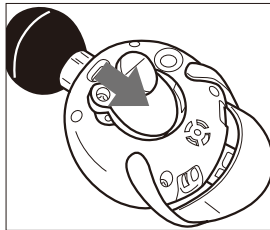

3. Align the tab on the battery cover with the indentation on the unit, replace the battery cover to its original position and tighten the screws in the clockwise direction. See “Attaching to a Tripod” (p.13) when attaching this device to a tripod for use.

*Be sure to remove the batteries when storing this device for a prolonged period (more than 3 months).

Reading the Display

- The display is shown in °C after inserting the battery.
- Press the ON/OFF button (⏻) to switch the display to °F.
- Press the MODE button (MODE) to switch the measurement details.

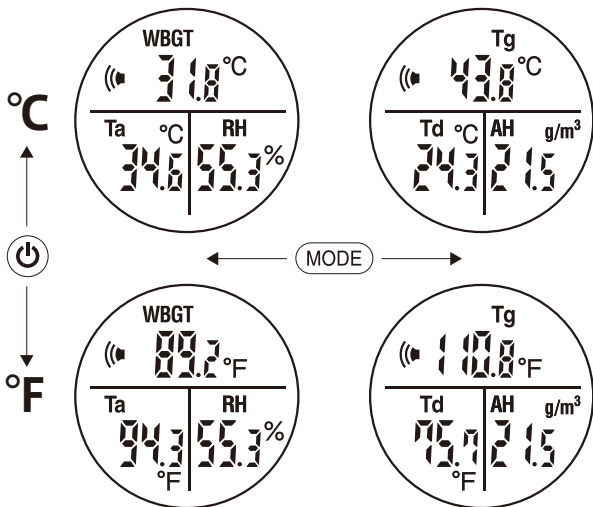

Display

Symbol	Function
WBGT	Wet Bulb Globe Temperature
Tg	Globe Temperature
Ta	Air Temperature
RH	Relative Humidity
Td	Dew point Temperature
AH	Absolute Humidity
🔋	Low Battery indicator

Display When the Measurement Range is Exceeded

The display changes as follows when the measurement range is exceeded.

WBGT	Flashes when the temperature is below 0.0°C (32.0°F)
	Flashes when the temperature is above 50.0°C (122.0°F)
Tg	Flashes when the temperature is below 0.0°C (32.0°F)
	Flashes when the temperature is above 60.0°C (140.0°F)
Ta*	Flashes when the temperature is below 0.0°C (32.0°F)
	Flashes when the temperature is above 50.0°C (122.0°F)
RH*	Flashes when the humidity is below 20%
	Flashes when the humidity is above 90%

*When Ta is flashing, RH, Td and AH displays are "---".

*WBGT is displayed when the RH display is flashing "20.0" or "90.0", but in this case consider the "WBGT" value as a reference value.

E.g.) When the Ta measurement exceeds the measurement range (0.0°C to 50.0°C/32.0°F to 122.0°F)

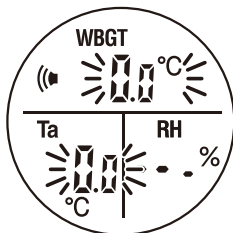

When the temperature is below 0.0°C

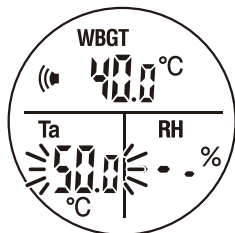

When the temperature is above 50.0°C

Setting the WBGT Alert Temperature

The alert alarm sounds when the WBGT alarm setting temperature is exceeded for every 10 minute interval when the power is ON.

1. When in the normal display, press and hold the ON/OFF button (⏻) and MODE button (MODE) together for 2 seconds.
→ The initial setting value for the alert temperature “25°C” (76°F) flashes.

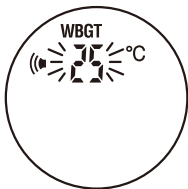

2. Press the MODE button (MODE) once to increase the alert temperature in 1°F (1°C) steps.
 - The alert temperature can be set within the range of “64°F to 104°F” (18°C to 40°C).
 - Press and hold the button to increase the steps quickly.

3. Press the ON/OFF button (⏻) to enter the alert temperature, and the display returns to the previous screen.
 - If there are no buttons pressed for 5 seconds, the alarm temperature returns to the previous display before the setting was changed, even if the ON/OFF (⏻) button is not pressed.

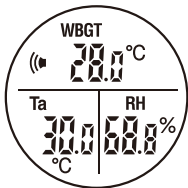

If the temperature exceeds the alert setting temperature, the alert alarm (beep beep) sounds for approximately 15 seconds.

→ Press the MODE button (MODE) or ON/OFF button (⏻) to stop the alert alarm.

*The alert temperature settings are only enabled for the WBGT values.

For more information

Please visit:
<http://www.tanita.eu>

Switching the Alert ON/OFF

Press and hold the MODE button (**MODE**) for approximately 2 seconds to toggle the alert on or off.

→The alert mark ((**■**)) lights when the alert is switched on.

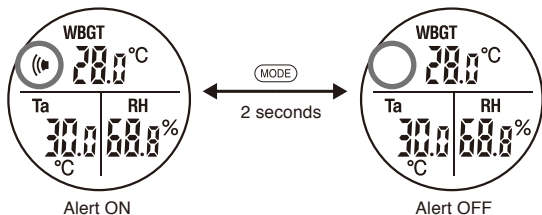

Back Light Function

Press the MODE button (MODE) and the back light lights for approximately 5 seconds.

Turning the Power Off

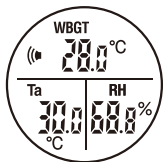

Press the ON/OFF button (⏻) for approximately 2 seconds.

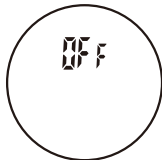

OFF is displayed for approximately 1 second, after which the device power turns off.

- The alarm does not sound when the power is off.
- Press and hold the ON/OFF switch (⏻) for approximately 2 seconds to turn the power on again.
“00” is displayed for approximately 1 second, and the power turns on.

Replacing the Battery

“” appears in the display when the battery is worn. Replace the battery (CR2032) with a new battery as soon as possible. See “Inserting the Battery” (P.5) for details.



Notice:

These marks can be found out on contaminant-containing Batteries:

Pb pb = Battery contains lead,

Cd Cd = Battery contains cadmium,

Hg Hg = Battery contains mercury.



Not allowed to mix batteries with consumer wastes!

As consumer you are legally bound to return used or discharged batteries. You can deposit your old batteries at the public collecting points in your town, or wherever the corresponding batteries are sold and specifically marked collecting boxes have been set up. In case of scrapping the apparatus, the batteries should be removed from it and deposited at the collecting points as well.

Attaching the Hanging Attachment

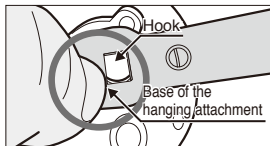

1. Align the square hole on the hanging attachment with the hook position on the battery cover, and press the base of the attachment firmly.

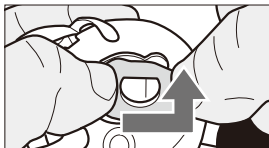

2. Use your other hand to pull the attachment and fit it into place from the front of the hook to the back.

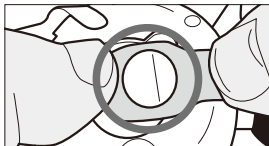

3. Move the hanging attachment sideways to check it is fitted correctly onto the hook.

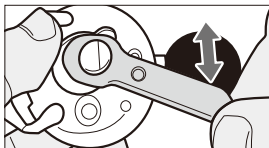

4. Align the attachment with the back position of the black globe as shown in the figure.

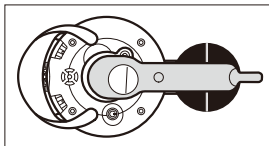

Caution

Do not pull the hanging attachment with too much force. Doing so may cause it to break. Be careful not to injure yourself when attaching this attachment.

Various Functions

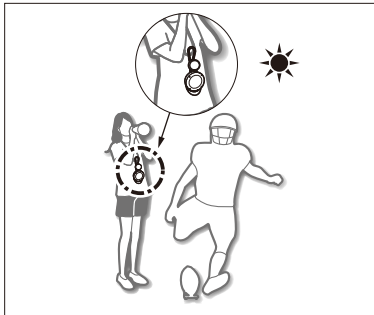

Wearing around the neck or waist

- Use the provided carabiner and a commercially available strap to wear around your neck.
- Use the provided carabiner to hang from a belt, etc.

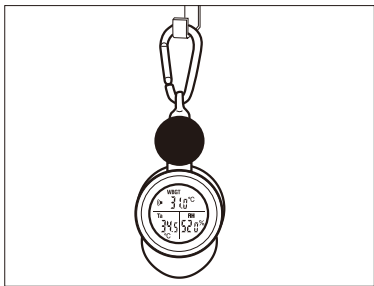

Hanging from a hook

(When using indoors)

- Use the provided carabiner to hang from a hook, etc.

Caution

Do not place directly on a bench or the ground (concrete, lawn, etc.). In such cases, the "Ta" value will be higher than normal, preventing accurate WBGT measurements.

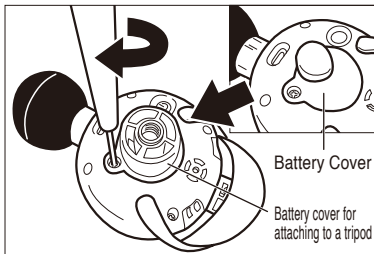

Attaching to a tripod

1. Replace the battery cover with the battery cover for attaching to a tripod.

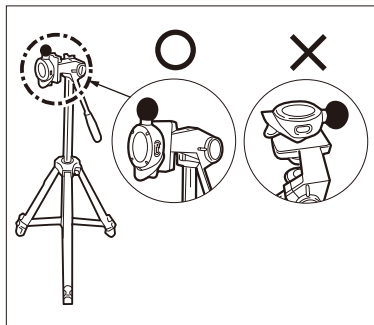

2. Attach to the tripod

⚠ Caution

Attach so that the black globe is upwards. If the black globe is facing sideways (display facing upwards), the "ambient temperature" etc. will be higher than normal, preventing accurate WBGT measurements.

*The tripod must be purchased separately.

*Refer to the tripod instruction manual when attaching this device to a tripod.

Specifications

WBGT	Resolution	0.1°C/°F unit
	Measurement Range	0.0°C to 50.0°C (32.0°F to 122.0°F)
	Accuracy	Calculated from the measured parameters
Globe Temperature	Resolution	0.1°C/°F unit
	Measurement Range	0.0°C to 60.0°C (32.0°F to 140.0°F)
	Accuracy	±3.0°C (±6.0°F)
Air Temperature	Resolution	0.1°C/°F unit
	Measurement Range	0.0°C to 50.0°C (32.0°F to 122.0°F)
	Accuracy	±1.0°C (±2.0°F)
Relative Humidity	Resolution	0.1%RH unit
	Measurement Range	20.0% to 90.0%
	Accuracy	±5.0% (35.0% to 75.0%) ±10.0% (other than the left)
Dew Point Temperature	Resolution	0.1°C/°F unit
	Measurement Range	-18.0°C to 48.0°C (-0.4°F to 118.4°F)
	Accuracy	Calculated from the measured parameters
Absolute Humidity	Resolution	0.1g/m ³
	Measurement Range	0.9g/m ³ to 74.6g/m ³
	Accuracy	Calculated from the measured parameters
WBGT/Ta/RH/Td/AH measurement interval		Once every 30 seconds
Alert	Duration of Sounding	Approximately every 15 seconds
	Volume	Over 75dB (10cm distance)
Power Supply		DC3.0V (CR2032× 1)
Battery Life		Continuous 360 hour use (with alert)
Dimensions		D36mm×W58mm×H108mm D1.4in×W2.3in×H4.3in
Weight		Approx. 65g (2.30oz) (including battery, hanging attachment and carabiner)

The product design and specifications may be changed at any time without prior notice.



This product complies with the EMC requirements of the European Community.

TANITA Europe B.V.

Hoogoorddreef 56-E
1101 BE Amsterdam
Tel: +31-20-560-2970
Fax: +31-20-560-2988
www.tanita.eu